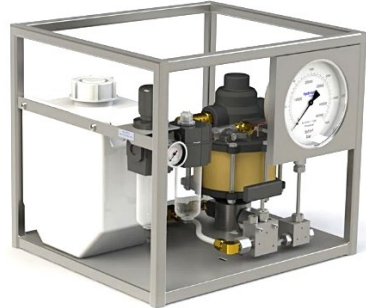

TECHNICAL DATA SHEET

PRODUCT	HPU-LW-1-58H-N*-L**/options	
SERIES	HPU-LW-1 Single Acting Air operated, hydraulic power pack for pressure testing, chemical injection and hydraulic power.	

FEATURES

- Infinitely variable output pressure and flow
- Holds static pressure without generating heat or consuming power
- Standard models are suitable for oil or water applications
- Well proven and trouble-free operation
- Designed for ease of maintenance
- Low cost servicing
- Robust construction

PERFORMANCE DATA

Max Rated Output Pressure	5,800psi (400bar)
Output Per Cycle	0.46 in ³ (8cc)
Max Flow	217 in ³ /min (3.6 litre/min)
Max Air Supply Pressure	100psi (7bar)
Ratio	58 : 1
Air Consumption	28 scfm (800 NI/min)
Tank Capacity	1.65 Gallons (7.5 litres)

SEAL OPTIONS (N*)

N* (standard)	Nitrile (Buna-N) Main Seal and Check Valve Seals
V	Viton (FKM) Main Seal and Check Valve Seals
C	Chemraz (FFKM) Main Seal and Check Valve Seals

CONSTRUCTION

Frame and Tank	Stainless Steel Frame & Plastic Tank
Air Motor	Anodised Aluminium / Wound Composite / Nitrile (Buna-N) Seals
Hydraulic Cylinder	Stainless Steel
Piston	Stainless Steel + Chrome Finish
Outlet Port	Stainless Steel
L1** (standard)	Nylon / Copper / Brass, Hydraulic / Air Inlet and Plated Steel Silencer
L2** (optional)	Stainless Steel, Hydraulic / Air Inlet and Silencer

CONNECTIONS

Hydraulic Outlet	1/2" NPT(F)
Air Inlet	3/8" BSPP(F)
Net Weight	19kg (42lb)

COMMON OPTIONS (BUT NOT LIMITED TO)

/ A	ATEX (94/9/EC) II 2GD c T5
/ Q	No tank-direct fluid inlet via Y type stainless steel strainer
/ V	No tank-direct hydraulic inlet via Y type brass strainer

GENERAL LAYOUT DRAWING

Model: **HPU-LW-1-58H**

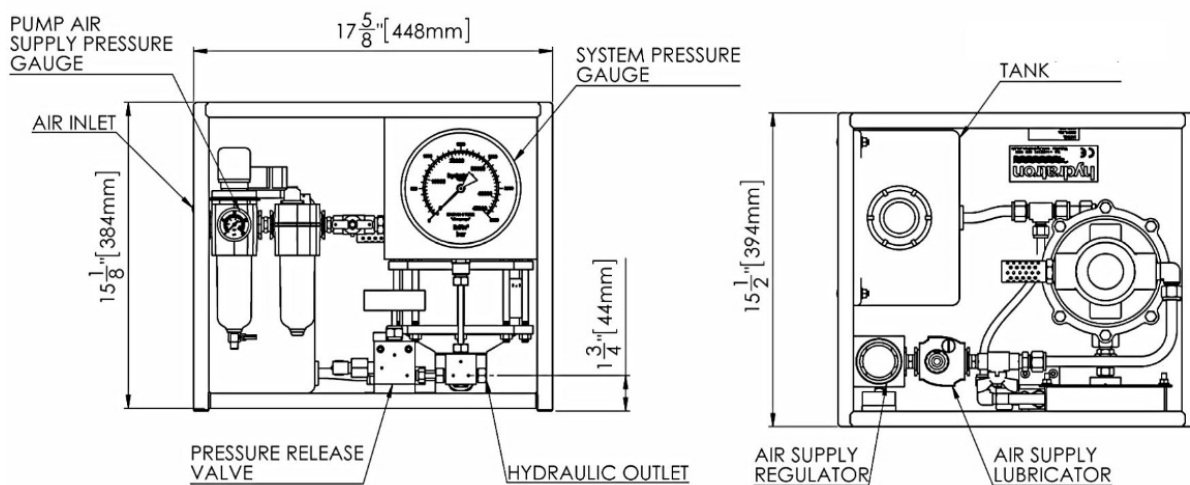

HYDRAULIC PRESSURE STATIC / STALL CONDITIONS

AIR PRESSURE	HYDRAULIC PRESSURE
20psi (1.4bar)	1,000psi (69bar)
40psi (2.8bar)	2,200psi (152bar)
60psi (4bar)	3,400psi (234bar)
80psi (5.5bar)	4,600psi (317bar)
100psi (7bar)	5,800psi (400bar)

FLOW CURVE

AZ-1-58 - Ratio 58:1

